

# STOVETOP FIRESTOP<sup>®</sup>

## MICROHOOD

### USER MANUAL

677-2 WHITE



6 55002 27998 7

**Read this user manual carefully  
prior to installation**

AUTOMATIC FIRE SUPPRESSION  
FOR GREASE FIRES ON INDOOR  
RESIDENTIAL STOVE TOPS (CLASS K)

The Original StoveTop FireStop<sup>®</sup>  
[www.STFS.com](http://www.STFS.com)

#### MANUFACTURER'S INFORMATION

Designed & Manufactured  
by WilliamsRDM in Texas

**Designed solely for suppressing  
stove top grease fires in  
indoor residential kitchens using no more  
than 3/8" of oil before food is added.**

**Contents:** Potassium Bicarbonate





For storage and disposal information,  
or to learn more about StoveTop FireStop,  
please visit our website at [www.STFS.com](http://www.STFS.com),  
or call 1-888-616-7976.

#### FIRE SAFETY



- Unattended cooking is the leading cause of fires in the kitchen. Many injuries occur when occupants attempt to fight the fire themselves.
- Never leave anything cooking on the stove top unattended! If you have to leave the kitchen—even for a short time—turn off the stove.
- Never leave home, or fall asleep while you are cooking.
- Never pick up a flaming pan. You may be burned, or if the pan is dropped, flames may quickly spread to other more flammable areas.
- Never use water to fight a grease fire! A violent explosion may result. Wet dishcloths or towels are also dangerous.
- Always follow National Fire Protection Association (NFPA) guidelines for proper cooking safety. Visit [www.nfpa.org](http://www.nfpa.org).

#### PARTS INCLUDED

ONE PAIR FOR EACH 4-BURNER COOKTOP  
*For indoor residential kitchens only. Not drawn to scale.  
Contact your supplier if missing any parts.*

- [A] Main units, Qty. 2 
- [B] Wall Brackets, Qty. 2 
- [C] Drywall Anchors, Qty. 4 
- [D] #8 Wood Screws, Qty. 4 
- [E] Wing Nuts, Qty. 2 

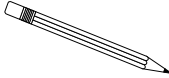
#### TOOLS NEEDED

- [F] Drill/Driver 
- [G] Pencil 
- [H] 1/8" (3 mm) drill bit 
- [J] #2 Phillips screwdriver or driver bit 

#### LIMITED WARRANTY

WilliamsRDM, Inc. ("WRDM") warrants this StoveTop FireStop<sup>®</sup> product against defects in material or workmanship for the time periods and under the terms set forth below. Pursuant to this Limited Warranty, WRDM will, at its option, (i) repair the product using new or refurbished parts or (ii) replace the product with a new or refurbished product. For purposes of this Limited Warranty, "refurbished" means a product or part that has been returned to its original specifications. **In the event of a defect, these are your exclusive remedies.**

WRDM warrants to the original retail purchaser all WRDM products for a period of one (1) year against defective material and faulty workmanship. Any unit found to be defective during the warranty period will be repaired if possible, or replaced free of charge upon the buyer's prepaid return of the defective unit—only after receipt of an official Return Material Authorization (RMA) number. Proof of retail purchase is required. This warranty gives the buyer specific legal rights which may vary by state (or country).

**THE FORGOING WARRANTY IS MADE IN LIEU OF ALL OTHER WARRANTIES WITH RESPECT TO THIS PRODUCT, INCLUDING**

**ANY IMPLIED WARRANTY OF MERCHANTABILITY OR FITNESS FOR A PARTICULAR PURPOSE—WHICH ARE HEREBY DISCLAIMED. THERE ARE NO IMPLIED WARRANTIES WHICH EXTEND BEYOND THE DESCRIPTION ON THE FACE HEREOF. NO PERSON IS AUTHORIZED TO GIVE ANY OTHER WARRANTY, OR TO ASSUME FOR WRDM ANY OTHER LIABILITY IN CONNECTION WITH THE SALE OR INSTALLATION OF ITS PRODUCTS. REPLACEMENT OF THE PRODUCT WILL BE THE SOLE REMEDY WITH RESPECT TO ANY LOSS OR DAMAGE TO PROPERTY. BUYER IS NOT RELYING ON SELLER'S JUDGMENT REGARDING BUYER'S PARTICULAR REQUIREMENTS AND BUYER HAS HAD AN OPPORTUNITY TO INSPECT THE PRODUCT TO BUYER'S SATISFACTION. UNAUTHORIZED SERVICE OF ANY KIND INVALIDATES ALL WARRANTY PROVISIONS.**

This Limited Warranty covers only the hardware components packaged with this product. It does not cover technical assistance for hardware. Any parts or product replaced under this Limited Warranty will become the property of WRDM.

**LIMITATION ON DAMAGES: WRDM SHALL NOT BE LIABLE FOR**

**ANY INCIDENTAL OR CONSEQUENTIAL DAMAGES, INCLUDING BUT NOT LIMITED TO ANY SUCH DAMAGES FOR ANY BREACH OF ANY EXPRESS OR IMPLIED WARRANTY ON THIS PRODUCT.**

Instructions: To obtain warranty service, you must deliver the product, freight prepaid, in either its original packaging, or packaging affording an equal degree of protection, to WRDM's specified manufacturing facility.

This Limited Warranty only covers product issues caused by defects in material or workmanship during ordinary consumer use; it does not cover product issues caused by any other reason, including but not limited to product issues due to commercial use, acts of God, misuse, limitations of technology, or modification of or to any part of the WRDM product. This Limited Warranty is invalid if either the factory-applied work order number or date code has been altered or removed from the product. This Limited Warranty is valid only in the United States.

**For StoveTop FireStop customer service:**  
go to [www.STFS.com](http://www.STFS.com) or call 1-888-616-7976.

#### ⚠ WARNING

- Not intended for cooking with more than 3/8" oil depth before food is added.
- Not recommended for gas stoves; powder may extinguish burner flame on a gas stove top
- Verify that there are no electrical or water lines where drilling.
- Do not disassemble the unit or remove fuse. Manufacturer is not responsible for units that have been disassembled or tampered with in any way.
- If safe, turn burner OFF immediately after activation.
- Reignition is possible.
- When suppressing powder comes in contact with fire, it may briefly flare and/or cause grease to splash. This is a normal and temporary reaction.
- This product may not suppress all stove top fires.

#### ⚠ CAUTION

- Keep away from children.
- Avoid exposure to suppressing powder if you wear contacts, or have a respiratory illness or skin allergies.
- Contents may be harmful if swallowed.
- Suppressing powder is non-toxic but could cause skin irritation. In case of contact with powder, flush from affected area with water.
- If irritation persists, contact a physician immediately.
- Discard product after activation.
- Discard product if dropped or damaged.
- Do not clean units.

#### NOTICE

- **Failure to remove or replace by the "remove or replace before" date, as shown on the product label, could diminish the effectiveness of the product.**
- This product activates automatically by direct, sustained contact with flame.
- At time of activation, a loud "POP" will occur. This is normal and meant to alert occupants, if present.

# INSTALLATION INSTRUCTIONS

## REQUIREMENT - HEIGHT

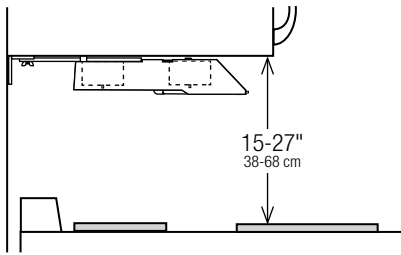

Must have 15-27" (38-68 cm) between surface of stove top and mounting point under microwave hood.

## REQUIREMENT - ALIGNMENT

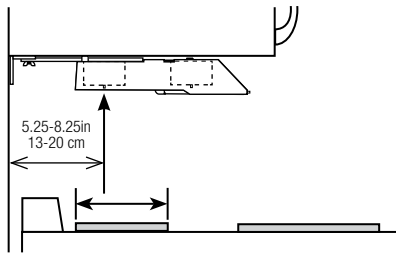

The center of the rear canister must be over the rear burner. If not, go to [www.STFS.com](http://www.STFS.com) to order an extension bracket kit.

## REQUIREMENT - MOUNTING

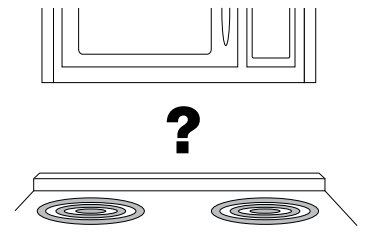

Wall bracket hardware included with purchase is intended for drywall installation only. If your backsplash material is not drywall, please visit [www.stfs.com/MH-install](http://www.stfs.com/MH-install).

## STEP 1

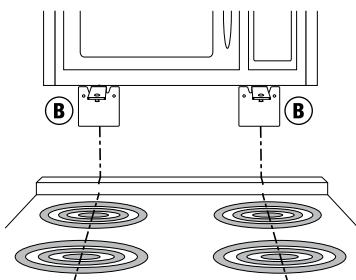

Align wall bracket [B] with center line of burners.

## STEP 2

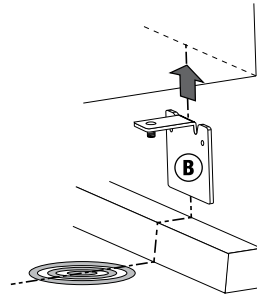

Slide wall bracket up to touch bottom of microwave or cabinet.

## STEP 3

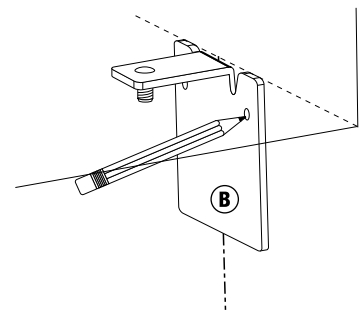

Mark location of bracket holes with a pencil.

## STEP 5

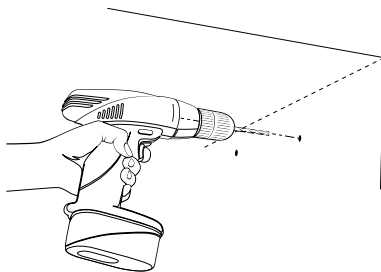

Drill 1/8" pilot holes in the marked locations. If wood stud is present behind drywall, proceed to Step 7.

## STEP 6

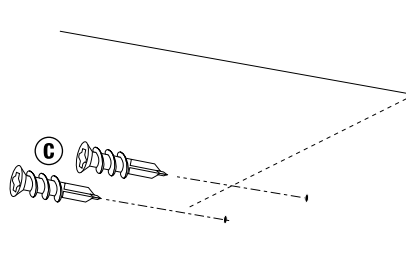

Tap anchors [C] into pilot holes. Hand tighten with #2 Phillips screwdriver (Use in drywall only.)

## STEP 7

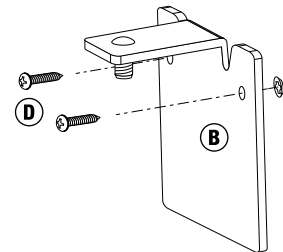

Align bracket [B] and attach with screws [D] (or use hardware suitable for your backsplash material).

## STEP 8

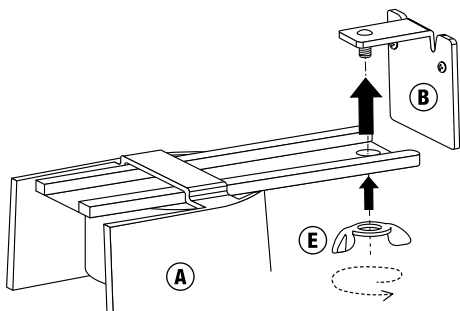

Secure main unit [A] to wall bracket [B] with wing nut [E]. Do not overtighten. Installation is complete.

## STEP 9

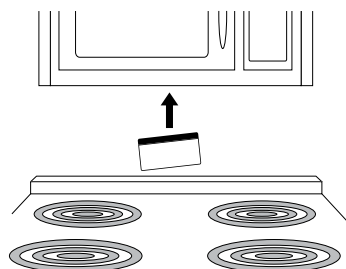

Place the enclosed decal where it can be seen under the microwave.